

75' DOUBLE BATTING TUNNEL FRAME INSTALLATION INSTRUCTIONS (66214D)

UNITS	REF #	DESCRIPTION	TOOLS NEEDED
9	1	Corner pole 4" square steel x 14'	1/4" Bolt cutter
6	2	Corner pole collar 4-1/2" sq. x 4"	9/16" Wrench (1)
3	3	Double pole collar 4-1/2" sq x 4"	7/16" Wrench (2)
6	4	Crossbar 2" O.D. x 15'8"	13' Ladder (2 recommended)
9	5	Black top cap	
9	6	24" Aluminum ground sleeve for 4" square pole	
18	7	Chain hook	
18		Steel c-snaps	
120		Plastic c-snaps	
500'		Chain	

FIGURE 1

ALL DISTANCE MEASUREMENTS ARE FROM CENTER TO CENTER:

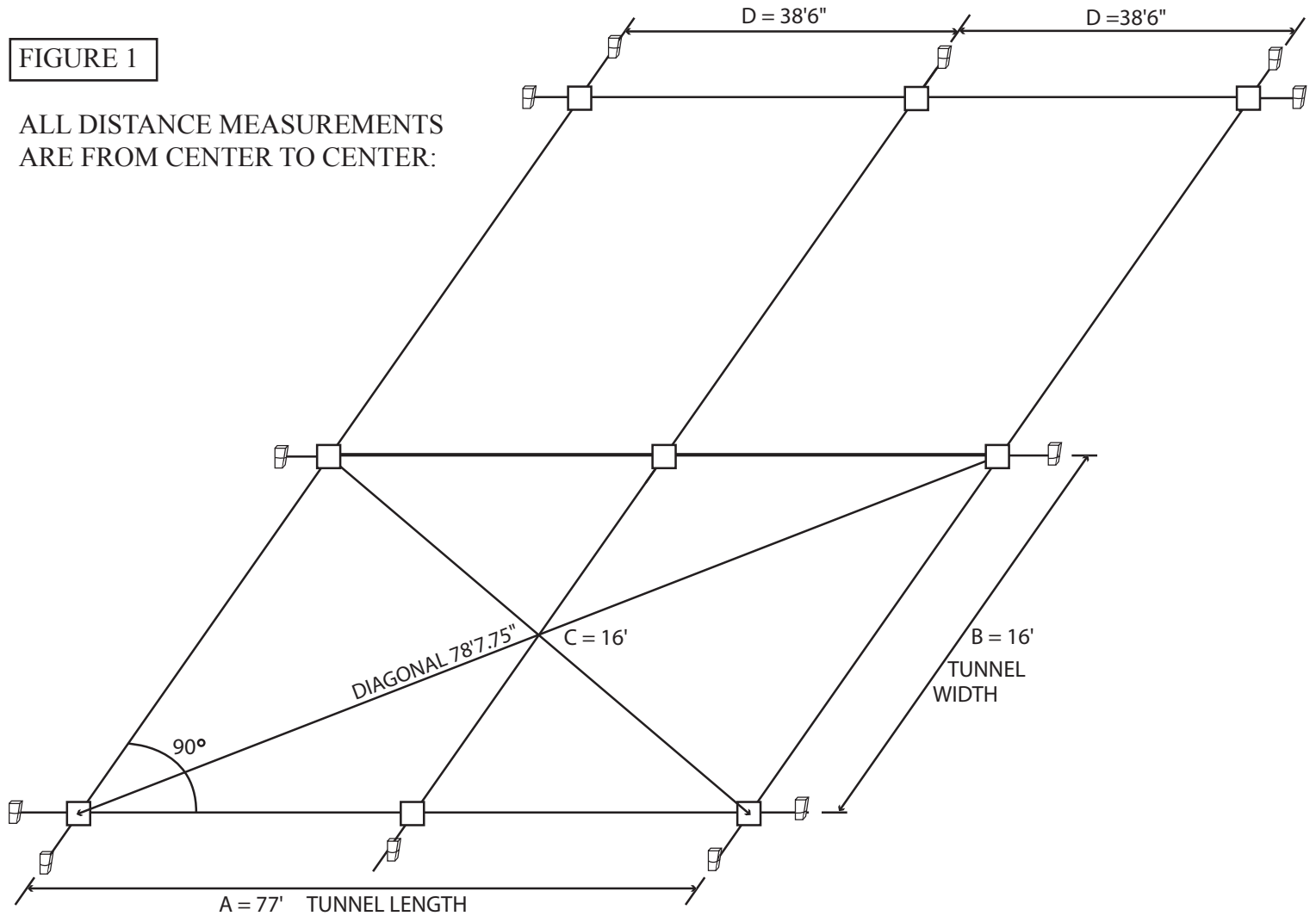

- Step 1** Locate corner and center pole locations as per Figure 1. Measure distances from center to center.
- Step 2** Dig one corner footing as shown in Figure 2 (36" minimum) and pour concrete in footing hole 2/3 full. Place square aluminum ground sleeve (ref #7) in concrete making sure the sleeve is square with the other three corner poles. Again, distances are from center to center.
- Step 3** Fill hole with concrete around sleeve up to ground level. Ground sleeve should be flush with top of concrete and straight.
- Step 4** Repeat steps 1-3 for remaining ground sleeves.

75' DOUBLE BATTING TUNNEL FRAME INSTALLATION INSTRUCTIONS (66214D)

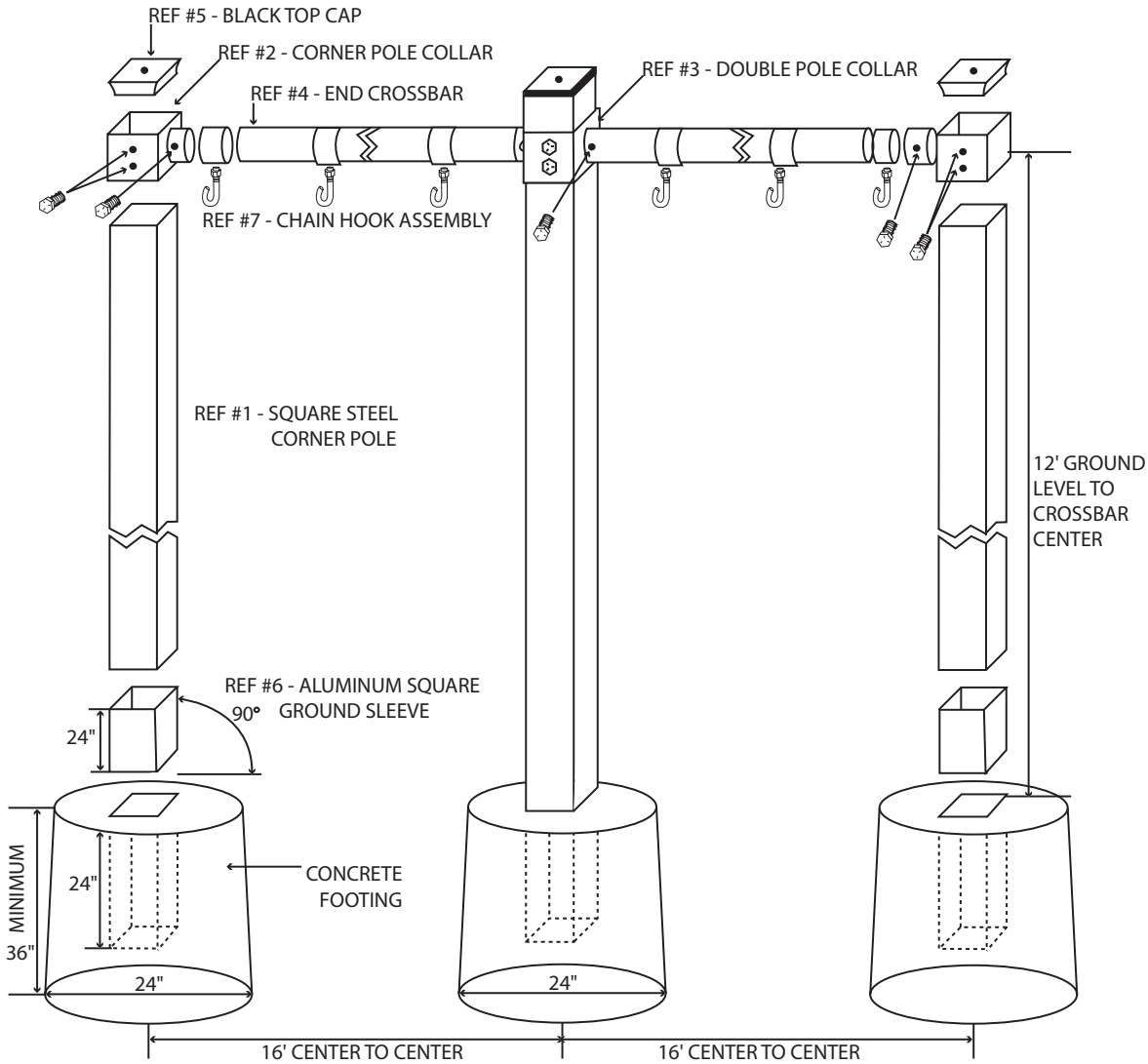

Step 1 Unroll the net and lay on the ground inside the frame. Locate the top border rope.

Step 2 Cut (3) pieces of chain to at least 80' lengths. Using the steel c-snaps, attach the chain to the chain hooks across the four crossbars. One piece for each side and one down the middle. Take out as much slack as possible. Have a minimum of 1' of chain on each end for adjustment when suspending the net.

Step 3 Starting at one corner attach the net to the chain using the plastic s-snaps. Start approximately 2' from the end cross bar. Continue down the net, placing a plastic c-snap every 3'. Next, attach the middle rope by starting on the outside for the end c-snap and then move to the inside of the tunnel for the remaining c-snaps. Repeat for the last chain.

NOTE: Taking the slack out of the chain will raise the net. Increasing the slack in the chain will lower the net.

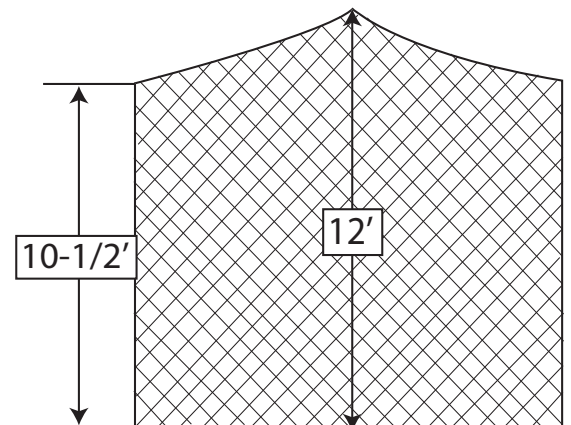
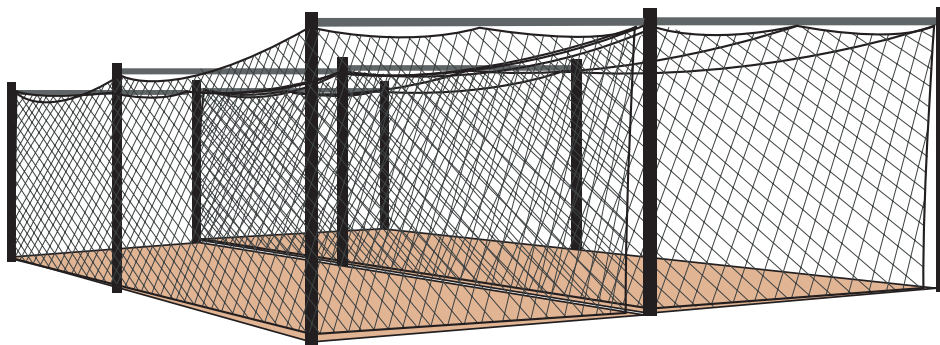

BATTERS VIEW OF CAGE

Note: The "slope" of the net is important. The center of the net, for its entire length is 12' high. The sides of the net are only 10 1/2' high, leaving 18" of net on ground to keep batted balls inside the enclosed area.